

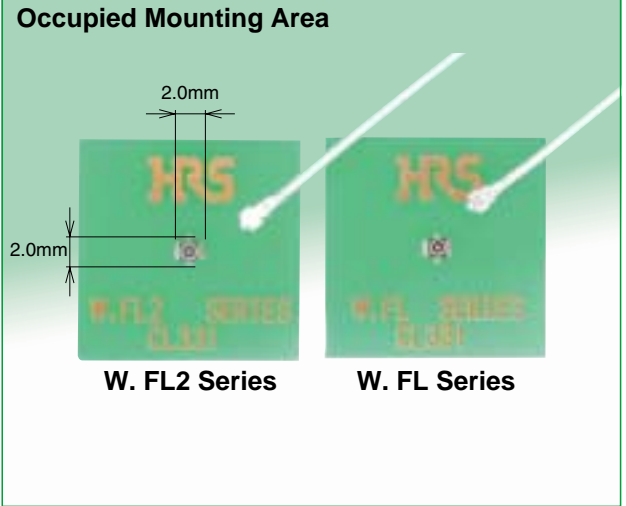

# Ultra-Small Surface Mount Coaxial Connectors - 1.18mm Mated Height

## W.FL2 Series



### Features

- 1. Nominal mated height of 1.18 mm (Max. 1.3 mm)**
- 2. Small board footprint**  
 As with W. FL Series, the receptacles occupies an area of 3.4 mm— and share the same land pattern.  
 Note: The W. FL2 Series and the W. FL Series are not compatible.
- 3. Extremely light weight**  
 Receptacle weight of 5.0 mg and plug weight of 17.4 mg makes the connectors one of the lowest weights on the market
- 4. Accepts high frequency transmission of DC to 6 GHz**  
 DC to 3 GHz: V.S.W.R. of 1.3 max.  
 3 GHz to 6 GHz: V.S.W.R. of 1.4 max.
- 5. Automatic board placement**  
 Packaged on tape-and-reel the receptacles can be placed with vacuum nozzles of the automatic placement equipment.
- 6. Plugs are terminated with ultra-fine coaxial (fluorinated resin insulated) cable**  
 Standard ultra- fine coaxial cable of 0.81 mm diameter (single braid shielding) is used for the plug termination, assuring secure and stable connections.
- 7. Simple connector mating / un-mating**  
 Use of the available mating / un-mating tools assures correct connection / disconnection of the plug and receptacle.

### Mated height comparison (with W.FL Series)

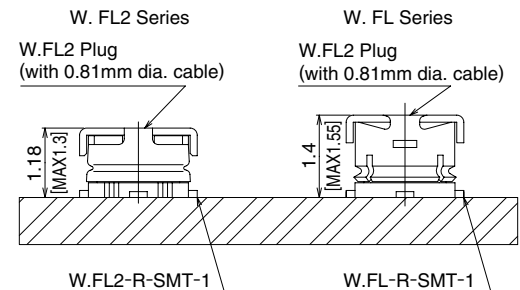

### W. FL2 Plug and Receptacle

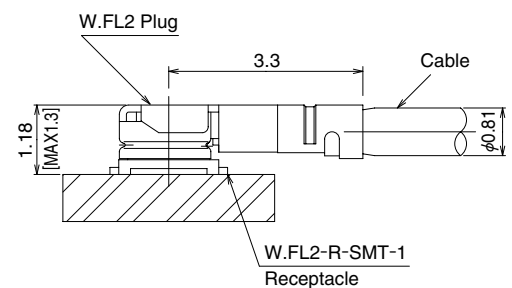

### Applications

Mobile phones, wireless LAN related applications, Bluetooth protocol devices, PDA, GPS, wireless communication devices, electronic measuring instruments and any application requiring high frequency transmission using ultra-small coaxial connectors.

# Wellshow



Wellshow Technology is the top manufacturer of mini coaxial cable assembly and RF connectors in Asia.



## Wellshow's strength

- Quick Lead Time
- Competitive price
- Complete quality management
- Full series of RF connectors
- Prompt technique support
- Systemized manufacturing procedure



## Product Range

### *Mini connector and Mini cable*

Hirose U.FL/ W.FL/ H.FL/ N.FL/ E.FL/ W.FL2  
IPEX MHF/ MHF 2 / MHF 3/ MHF 4  
Murata GSC/ HSC

### *RF connector and RF cable*

SMA / SMB / SSMB / SMC / MMCX /  
MCX / FME / BNC / TNC / N ...etc.



## Contact us

Tel: +886-2-24270488  
Fax: +886-2-24260387

9F., No.181, Nanrong Rd., Ren-ai Dist.  
Keelung City 200, Taiwan

**W.FL2 Series Ultra-Small Surface Mount Coaxial Connectors - 1.18mm Mated Height**

**Specifications**

Rating	Nominal characteristic impedance	50Ω	Operating temperature range	-40°C to +90°C (RH 90% max.)
	Frequency range	DC to 6 GHz	Storage temperature range	-30°C to +70°C (RH 90% max.)Note 1

Item	Specification
1. Contact resistance	20 mΩ max. (center contact), 10 mΩ max. (outer contact)
2. Insulation resistance	500 MΩ min., 100 V DC
3. Withstanding voltage	200 V AC / 1 minute
4. V.S.W.R.	1.3 max. (DC to 3 GHz) 1.4 max. (3 GHz to 6 GHz)

\* V.S.W.R. Measurement

as shown on the block diagram below.

Note: Verify connection and measurement setup.

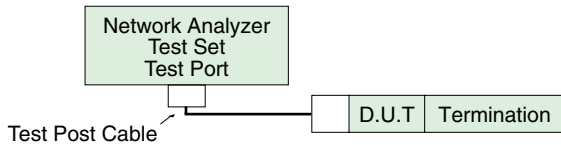

Note1: Cable assembly measurements with SMA conversion adapters mated with W.FL2 plug at each end of the 100cm long ultra-fine coaxial cable.

Note2: Receptacles mounted on a 50 ohms glass epoxy board.

Measurements were conducted with SMA conversion adapters attached.

Note1. The term "storage" refers to products stored for long period of time prior to mounting and use.

**Materials**

**Plugs – Right Angle**

Part	Material	Finish
Shell	Phosphor bronze	Silver plated
Insulator	PBT	Color: Black, UL94V-0
Female center contact	Phosphor bronze	Gold plated

**Receptacle**

Part	Material	Finish
Shell	Phosphor bronze	Silver plated
Insulator	LCP	Color: Black, UL94V-0
Male center contact	Brass	Gold plated

**Plugs**

**Cable**

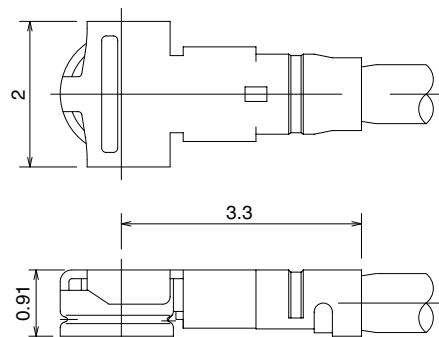

All dimensions: mm

**Plugs can be ordered only as terminated cable assemblies.**

## How to Specify Cable Assembly

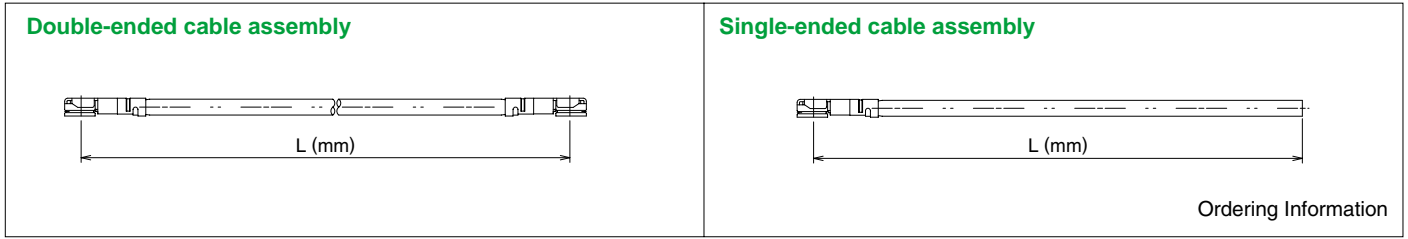

### Ordering Information

**W.FL2 - 2LP - 04N [ ] - A - (L)**

①                      ②                      ③                      ④                      ⑤

**W.FL2 - LP - 04N [ ] - A - (L)**

①                      ②                      ③                      ④                      ⑤

### Standard tolerances for (L)\*\*

(L)(mm)	Standard Tolerance (mm)
*L=35 to 200	±4 mm
L=200 to 500	±8 mm
L=500 to 1000	±12 mm
L=Longer than 1000 mm /	±1.5% of (L)

- \* Minimum available length (L) is 35mm
- \*\* Contact nearest HRS representative if different tolerances are required.
- \*\*\* Contact Nearest HRS representative if one end requires preparation.

① Series name	W.FL2	④ Cable color	1: White, 2: Black
② Assembly type	LP : Single ended 2LP : Double ended	⑤ Total length (mm)	Length (L)
③ Cable type	04N : 0.81mm dia. ultra-fine coaxial cable		

## Receptacles

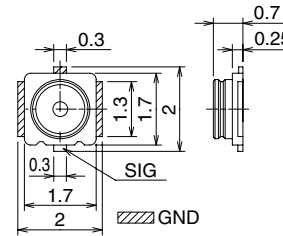
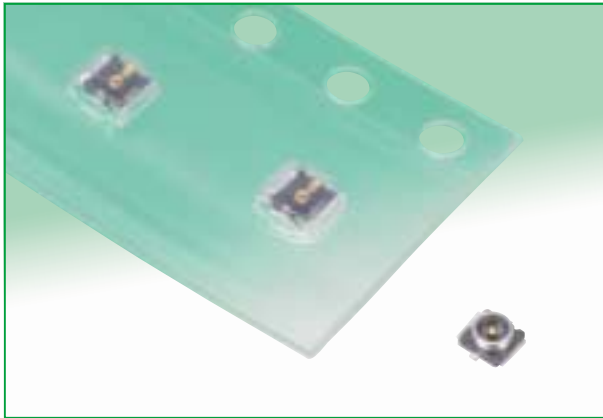

Part Number	CL No.	Packaging	Weight/EA	RoHS
W.FL2-R-SMT-1(10)	331-0315-4-10	Reel (2,000 pieces per reel)	5.0mg	YES
W.FL2-R-SMT-1(40)	331-0315-4-40	Reel (5,000 pieces per reel)		

### Recommended PCB mounting pattern (Note 1)

Note 1: The land pattern is the same as that of the W. FL series connectors.  
 Note 2: Recommended metal mask thickness: 0.1mm to 0.12mm

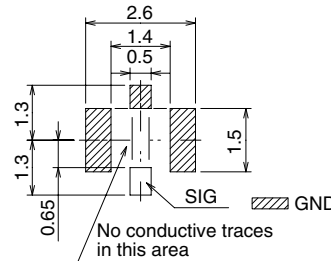

### Packaging Specifications

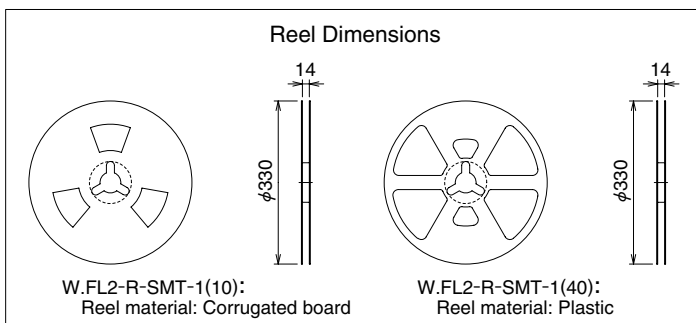

## ■ Conversion Adapters

### ● SMA Conversion Adapter (W.FL2 side jack – SMA side plug)



Note: Used for performance measurements only.  
 The W.FL mating side has lower retention force when mated with the corresponding part.

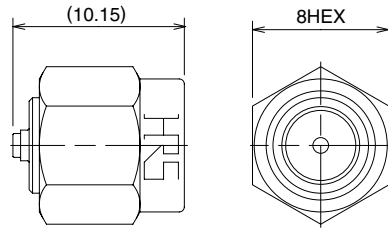

All dimensions: mm

Part Number	CL No.	RoHS
HRMP-W.FL2J	311-0394-6	YES

### ● SMA Conversion Adapter (W.FL2/W.FL side plug – SMA side jack)



Note: Used for performance measurements only.  
 The W.FL mating side has lower retention force when mated with the corresponding part.

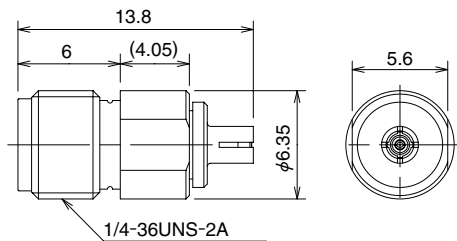

All dimensions: mm

Part Number	CL No.	RoHS
HRMJ-W.FLP(40)	311-0368-6-40	YES

### ● SMA Conversion Adapter



Note: When mating with corresponding part (W.FL2-R-SMT-1) must be pressed down and held to make complete connection.

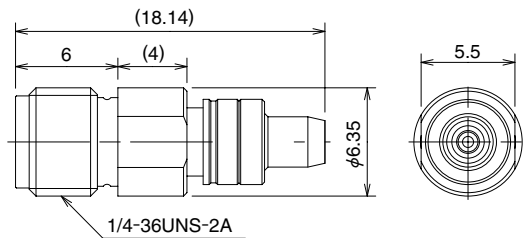

All dimensions: mm

Part Number	CL No.	RoHS
HRMJ-W.FL2P-ST3	311-0417-0	YES

## ■ Receptacle Inspection Adapter (W.FL2/W.FL)

Used for inspecting the performance parameters of the cable assembly.

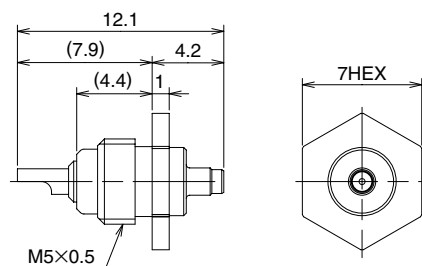

All dimensions: mm

Part Number	CL No.	RoHS
W.FL-R-1	331-0483-9	YES

## Tools

### ● Plug - Mating /Unmating

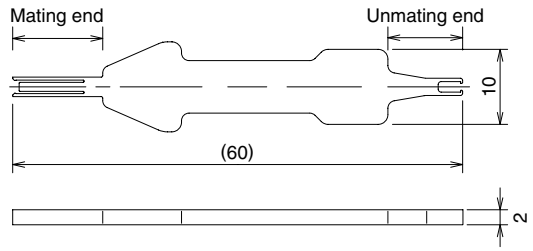
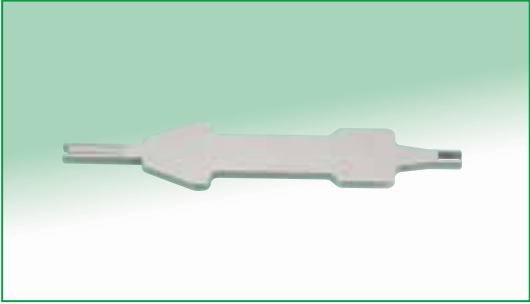

Part Number	CL No.	RoHS
W.FL2-LP-IN.OUT	CL331-0321-7	YES

### ● Plug - Mating

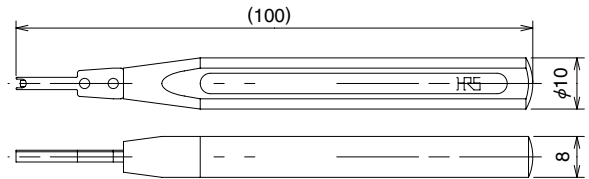

Part Number	CL No.	RoHS
W.FL-LP-IN	CL331-0323-2	YES

Note: Can be used with W.FL or W.FL-LP(G) plugs.

**W.FL2 Series Ultra-Small Surface Mount Coaxial Connectors - 1.18mm Mated Height**

**■Precautions**

**1. Plugs**

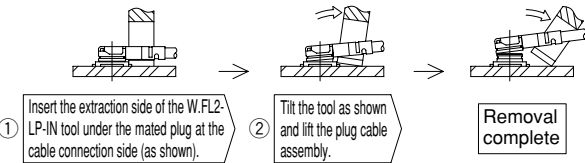
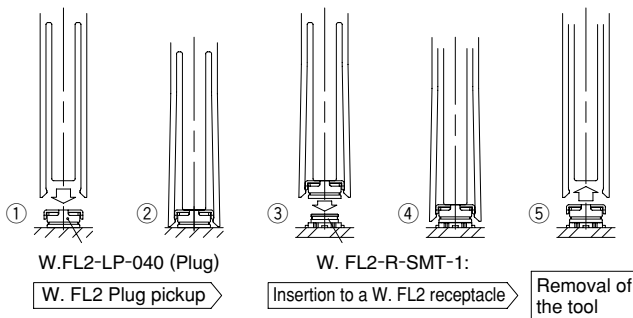
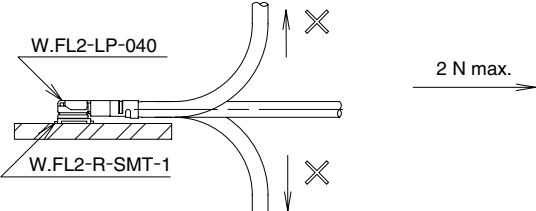
<p>(1) Mating / unmating</p>	<p>① To disconnect connectors, insert the extraction side of insertion and extraction jig W.FL2-LP-IN.OUT and perform as described in the diagram below.</p> <p><b>• Unmating</b></p>  <p>① Insert the extraction side of the W.FL2-LP-IN tool under the mated plug at the cable connection side (as shown).          ② Tilt the tool as shown and lift the plug cable assembly.          Removal complete</p> <p><b>• Mating</b></p> <p>① Align the mating tool W.FL-LP-IN or the mating end of the tool W.FL2-LP-IN.OUT over the plug end of the cable assembly.          ② Firmly place the tool over the plug until it is secured in the tool.          ③ Place the plug cable assembly (held in the tool) over the corresponding receptacle.          ④ Assuring that the plug and receptacle are aligned press-down perpendicular to the mounting surface until both connectors are fully mated.          ⑤ Remove the mating tool by carefully pulling it up. Removal of the tool</p>  <p>W.FL2-LP-040 (Plug) → W.FL2 Plug pickup → Insertion to a W.FL2-R-SMT-1 → Removal of the tool</p> <p><b>● Use of the extraction tool is absolutely mandatory. Any attempt of unmating by pulling on the cable may result in damage and affect the mechanical / electrical performance.</b></p>
<p>(2) Pull forces on the cable after connectors are mated</p>	<p><b>• Plug</b></p>  <p>Do NOT apply any pull forces after the bending of the cable.</p> <p>2 N max.</p>
<p>(3) Precautions</p>	<p>Do not twist connectors excessively during mating / unmating.</p>

**2. Receptacles**

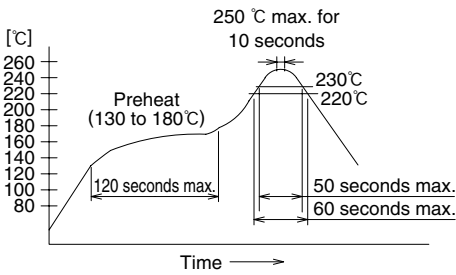
<p>(1) Recommended reflow temperature profile</p>	 <p>250 °C max. for 10 seconds</p> <p>Preheat (130 to 180°C) 120 seconds max.</p> <p>230°C 220°C</p> <p>50 seconds max. 60 seconds max.</p> <p>Time →</p> <p>① The temperature of the printed circuit board surface temperature at the points of contact with the terminals.          ② Reflow soldering should be performed at a printed circuit surface temperature of 250°C max.          ③ In individual applications the actual temperature may vary, depending on the solder paste type, volume / thickness and board size / thickness. Consult your solder paste and equipment manufacturer for specific recommendations.</p>
<p>(2) Recommended metal mask thickness</p>	<p>0.1 mm to 0.12 mm</p>
<p>(3) Reflow cycles</p>	<p>2 times</p>

**3. Operating environment and storage conditions**

<p>(1) Operating environment</p>	<p>The connectors are NOT designed to operate in the following environments:</p> <ul style="list-style-type: none"> <li>• Exposed to a excessive amounts of fine particles and dust</li> <li>• Regions and places having a high density of sulfur dioxide, hydrogen sulfide, nitrogen dioxide or other corrosive gasses.</li> <li>• Environments having large rapid variations in temperature.</li> </ul>
<p>(2) Storage conditions - Receptacle</p>	<p>Store in the Hirose Electric packaging.          Temperature: -10 to +40°C, Humidity: 85% max.          Use within 6 months of delivery.          Receptacles for which the storage period has elapsed must be tested for solderability to the PC board mounting surface.</p>



**HIROSE ELECTRIC CO.,LTD.**  
 5-23,OSAKI 5-CHOME,SHINAGAWA-KU,TOKYO 141-8587,JAPAN  
 PHONE: 81-3-3491-9741, FAX: 81-3-3493-2933  
<http://www.hirose.com>  
<http://www.hirose-connectors.com>